



## WARN Industrial Hoist

**Model**

**Part Number**

**Motor Type**

**DC3000-CCW**

**63897**

DC Electric  
12 Volt  
Series Wound

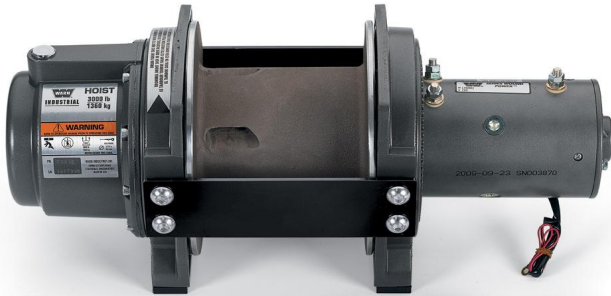

The DC3000 hoist combines a powerful series wound DC motor with robust sealing and our proven 3-stage all metal geartrain. Permanent grease lubrication means years of trouble free service. All WARN hoists incorporate an automatic mechanical brake that holds full rated load. The durable powder coated finish stands up to the elements and looks great. The DC3000 hoist is built on WARN's robust large frame design with a cast aluminum drum to provide plenty of wire rope capacity. Controls and accessories available separately.

### Accessories

Description:	Part Number
Control Pack-12V	39602
Contactorm Only-12V (Standard bracket)	34969
Contactorm Only-12V (w/ bracket for cover)	34975
Contactorm Cover (with remote plug)	36648
Contactorm Cover (no plug)	35169
Remote Control Only	34462

\*CW model shown in photo. Always observe correct drum rotation.

### Engineering Data

Rated Capacity:	3000 lbf	1361 kgf
Drum Barrel Diameter:	5.31 in	135 mm
Drum Flange Diameter:	8.9 in	226 mm
Distance Between Flanges:	5.94 in	151 mm
Recommended Maximum Wire Rope Diameter:	5/16 in	7.9 mm
Recommended Minimum Wire Rope Breaking Strength:	10540 lbf	4781 kgf
Approximate Shipping Weight:	83.0 lb	37.6 kg
Duty Cycle (intermittent per SAE J706 section 6.2):	N/A ft	N/A m
Mounting Bolt Torque:	35 - 40 ft*lbf	47 - 54 N*m
Maximum Layers of Wire Rope:	4	
Gear Reduction:	199	
Brake Type:	Automatic Disc	
Contactorm/Remote Type:	Not Included	

### Drum Rotation

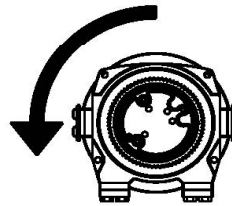

Viewed from Motor End

### Standards Compliance

1. - CE Machinery Directive 98/37/EC and 2006/42/EC
2. - CE Electromagnetic Compatibility 2004/108/EC
3. - ASME B30.5

### Performance By Layer

Drum Layer	Line Load *			No Load Line Speed		Drum Capacity	
	lbf	kgf	kN	ft/min	m/min	ft	m
1	3000	1361	13.3	30.4	9.3	25	7.6
2	2700	1225	12.0	33.7	10.3	54	16.5
3	2454	1113	10.9	37.1	11.3	85	25.9
4	2250	1021	10.0	40.5	12.3	119	36.3

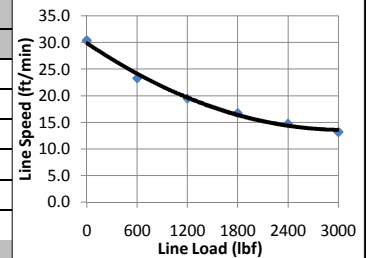

\* Never exceed the Rated Capacity. Installation of a Rated Capacity Limiter is recommended.

### First Layer Performance

Line Load		Current Draw	Line Speed		Duty Cycle
lbf	kgf	Amps	ft/min	m/min	min/10min
0	0	87	30.4	9.3	5.0
600	272	116	23.3	7.1	3.4
1200	544	143	19.5	5.9	2.5
1800	816	172	16.8	5.1	2.1
2400	1089	202	14.8	4.5	1.7
3000	1361	231	13.2	4.0	1.5

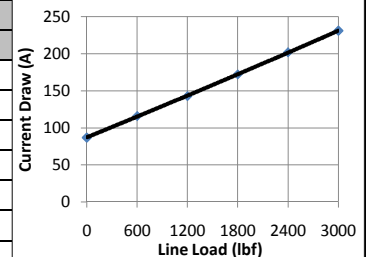

**WARN INDUSTRIES, INC**  
Industrial Products

Customer Service (North America): 1.800.543.9276  
Customer Service (International): 1.503.722.3008  
FAX: 1.503.722.3000 www.warn.com

12900 S.E. Capps Road,  
Clackamas, OR USA 97015







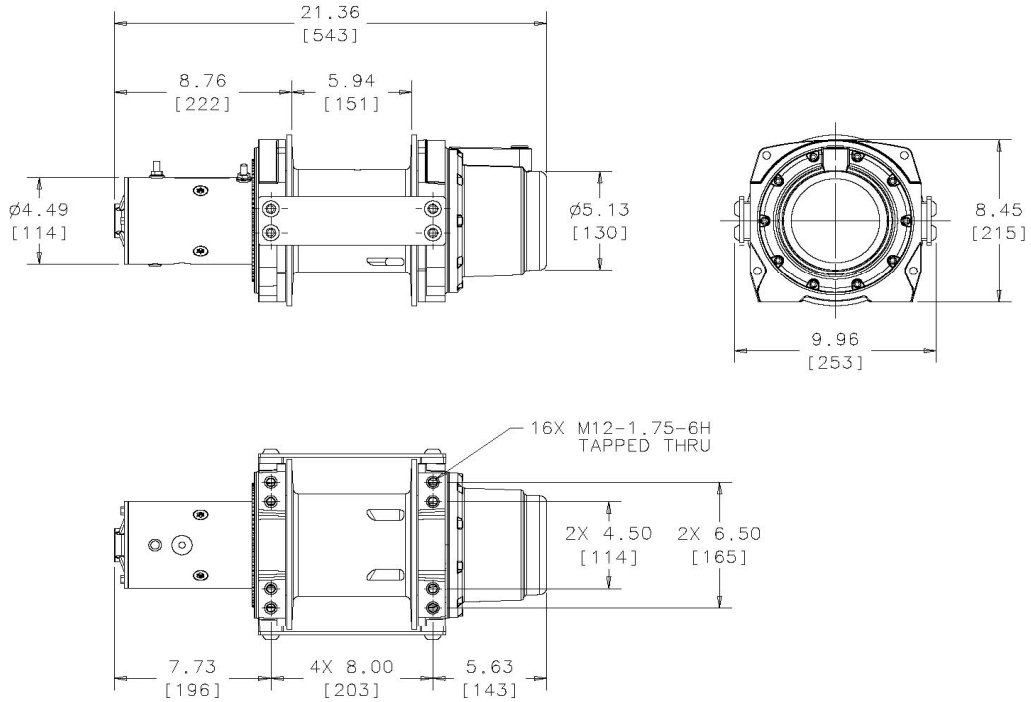

# WARN Industrial Hoist

Model	Part Number	Motor Type
DC3000-CCW	63897	DC Electric 12 Volt Series Wound

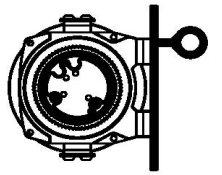

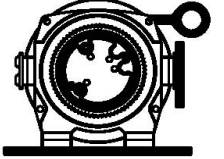
Units are given in inches [millimeters], unless otherwise specified

Recommended Mounting (Always Observe Correct Drum Rotation)			Electrical System Specifications
<p>Pull from bottom of hoist</p>  <p>Feet down</p>	<p>Pull from bottom of hoist</p>  <p>Feet forward</p>	<p>Pull from top of hoist</p>  <p>Feet forward</p>	<p>See Electrical Cable Gauge Size Chart for cable sizing</p> <p>All electrical connections must be clean and tight</p>
<p><b>Electrical System Wiring Schematic</b></p> <p>Hoist provided without electrical controls. See accessories on front page for control kits. Use of a dynamic braking contactor is recommended with series wound motor hoists.</p> <p>Power IN (Hoisting)- Connect motor terminal F1 to positive. Connect motor terminal F2 to motor terminal A. Connect motor ground point to negative (Ground).</p> <p>Power OUT (Lowering)- Connect motor terminal F2 to positive. Connect motor terminal F1 to motor terminal A. Connect motor ground point to negative (Ground).</p>			
<p>Pull from top of hoist</p>  <p>Feet down without angle brace</p>	<p>Pull from top of hoist</p>  <p>Feet down with angle brace</p>	<p>Pull from top of hoist</p>  <p>Angle Braces Only</p>	<p>Notes:</p>

**WARN INDUSTRIES, INC**  
Industrial Products

Customer Service (North America): 1.800.543.9276  
Customer Service (International): 1.503.722.3008  
FAX: 1.503.722.3000 www.warn.com

12900 S.E. Capps Road,  
Clackamas, OR USA 97015